

Unbreakable Security
Timeless Peace



Top Security Doors



Top Security Doors

Our doors are beautifully designed and handcrafted to suit the exact specifications of our clients.

Our expert technicians are constantly on-hand to customize our products and tailor them to the tiniest detail.

We pride ourselves on our staff, who are trained and certified in every aspect of professional installation, and come from decades of experience in the field.

Contents

Traditional Doors	3
Contemporary Doors	6
Commercial Doors	8
Security Door Classes	10
Locks & Cylinders	16
Millings	18
Standard Carvings	19
Door Finishes	21
Door Ironmongery	25
Available Upgrades	27
Gallery	29

Traditional Doors

Our doors are not only strong and stylish, but can also match traditional designs to make sure that your house looks like a home, not a fortress. At our company, we fully appreciate the importance of security. That's why we take great care to ensure our clients can have complete confidence in our work, giving them a genuine sense of safety – as well as style and sophistication. We can enhance even the most beautiful homes, equipping them with the strength and resilience of a fortress.

We specialise in designing and building security doors to meet your exacting and unique specifications. Whether you have your own bespoke designs, want a heritage replica, or something entirely custom, we use advanced 3D simulation and AutoCAD technology to bring your vision to life. Once we've carefully planned every detail, our state-of-the-art manufacturing facilities turn your ideas into reality with the utmost precision.

Accurate measurements, photographs of neighbouring properties, and physical samples of the original door are all used to engineer an exact replica that fully complies with Heritage regulations for conservation areas.



Traditional Doors



Replica Doors

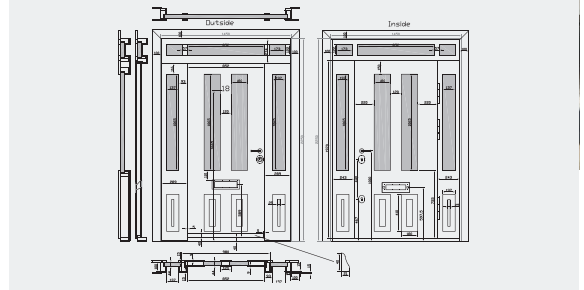
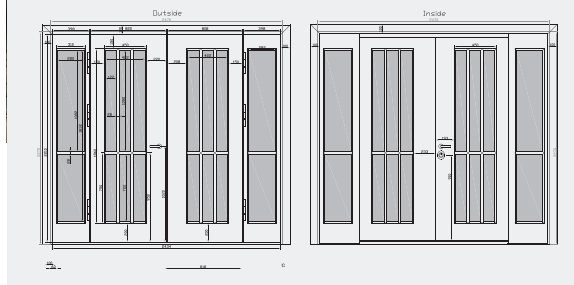
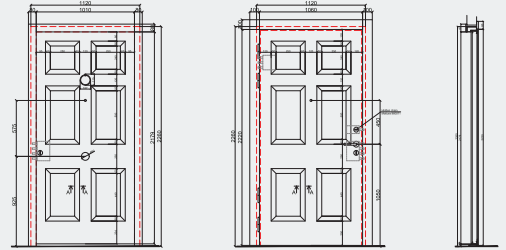

Contemporary Doors

Our doors are designed to complement the style and ambiance of your beautiful home. Ensuring a perfect fit and providing maximum security and durability are our top priorities.

Every door we manufacture is meticulously designed and tested for accuracy using computerized processes throughout each stage of production to ensure the highest quality.

Every single aspect of your home's security will be guaranteed to be a hundred per cent impregnable in the hands of our staff.

You are free to choose any door design and colour, whether for inside or outside. This gives you the flexibility to seamlessly match your new door with your existing interior or exterior decor.

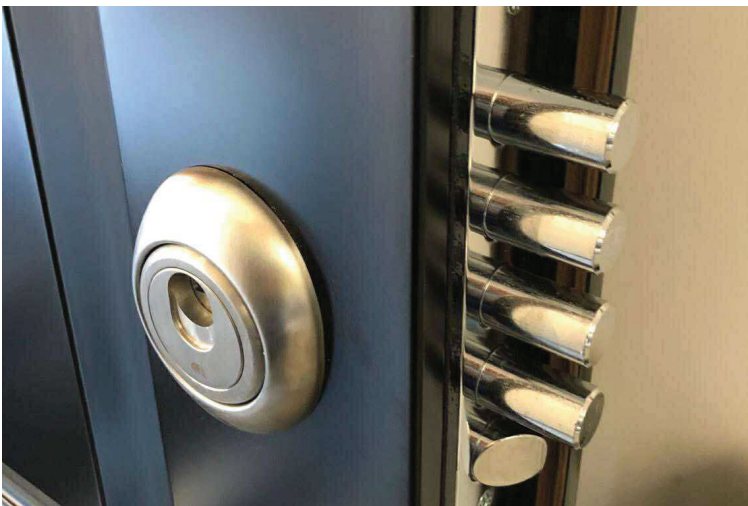

Contemporary Doors



Commercial Doors

Commercial premises are particularly vulnerable to break-ins, and statistics show that a property that has been burglarized once is four times more likely to be targeted again. Every intrusion increases the risk to your premises. Trust us to strengthen your business's defenses with robust, secure doors that protect your dreams and ideals, keeping out unwanted visitors and safeguarding what matters most.

While the needs of our commercial clients are different from our home-owners, we acknowledge that the core of these needs are similar: the need for security. Our commercial range of doors are engineered to suit the distinctively organisational look and purpose of a business, while strengthening our business clients from the very core of true security.



Commercial Doors





Security Door Classes

RC1 – Basic Security

1. Door frame – 80 mm wide special bended shape profile is fitted in to the wall by 8 screws 3.
2. Thermal insulation 50 mm rock wool.
3. Cut protective roll pins for door hinges (Ø12 mm) – 4 items.
4. Insulation seals – 2 items.

Oversize	Not possible
Number of hinges:	2
Design & colour	Any design and finish
Architraves:	Included, 80 mm x12 mm, 45°, Glued (no holes)
Colour of Metal constr.	Any
Main Lock:	FIAM 678 multi-directional lock ISEO R6 Plus (1 + 5 keys)
Hidden chain/night lock	Not possible
Magnetic defender	Not possible
Outside handle/knob	Included
Inside handle	Included
Glass	Not possible
Fire resistance	Possible for 30 min
Threshold:	Powder coated 15x20x80 mm
Metal construction:	For inside or outside conditions
Bullet resistance:	Not possible
Adjustable frame plate	n/a
Additional upgrades:	Spy hole Overhead door closer Drop down door seal Security type letter box Alarm sensor
Packing:	Wooden box



Cross section

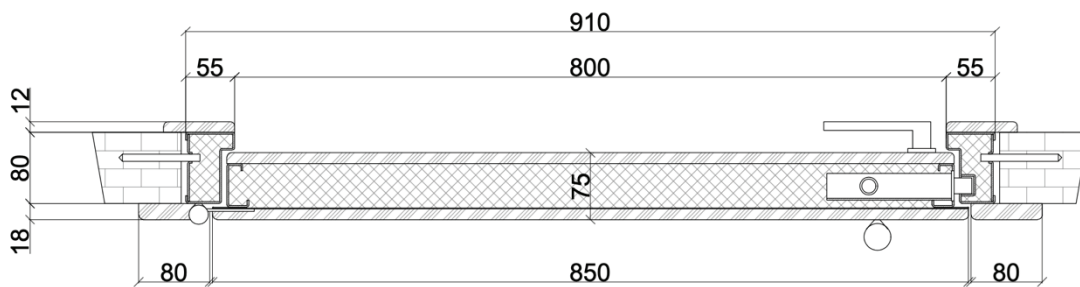

RC3 – High Security – 700 mm metal crowbar resistant

1. Door frame – 100 mm wide special bended shape profile is fitted in to the wall by 16 screws protected with Ø24mm steel liners.
2. Thermal insulation 50 mm rock wool.
3. Cut protective roll pins for door hinges (Ø16 mm) – 4 items.
4. Insulation seals – 2 items.

Oversize	Possible
Number of hinges:	3, adjustable
Design & colour	Any design, finish, shape and colour
Architraves:	Included, 100 mm, x12 mm 45°, Glued (no holes)
Colour of Metal constr.	Any
Main Lock:	FIAM 678 multi-directional lock in protective metal box ISEO R6 Plus (5 keys) key – thumb turn (modular)
Outside handle/knob	Included
Inside handle	Included
Glass	Possible, security laminated, P5A, burglar proof
Fire resistance	Possible for 45 min
Threshold:	Stainless steel 15x20x100 mm
Metal construction:	For inside or outside conditions
Bullet resistance:	Possible up to FB4, standard steel
Adjustable frame plate	Included
Additional upgrades:	All the same as RC1 and below: L-shape architraves Motorised lock with finger print scanner, key pad or mobile phone connection Concealed door closer Extra MOTTURA bolts Extra lock Hidden chain/night lock Magnetic defender
Packing:	Wooden box

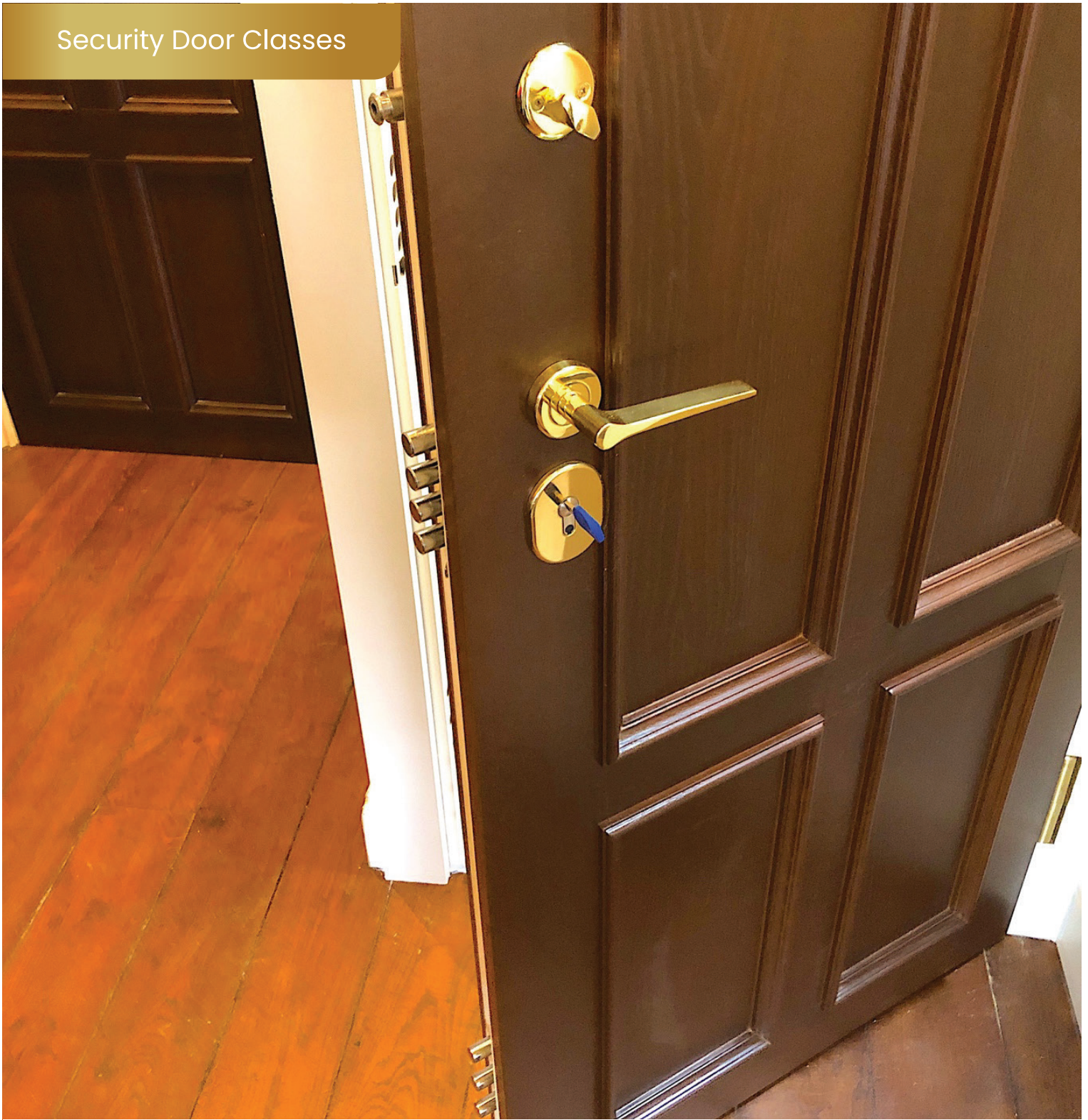

Cross section

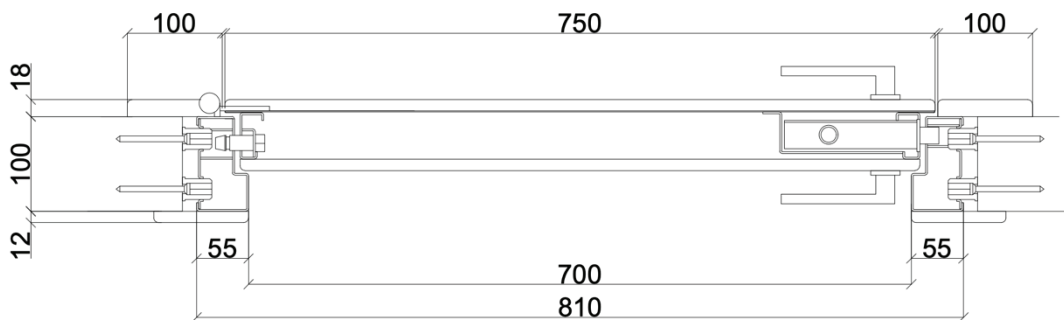

RC4 – Highest Security – resistant to motorised tools

1. Door frame – 115 mm wide special bended shape profile is fitted in to the wall by 20 screws protected with Ø24mm steel liners.
2. Thermal insulation 60 mm rock wool.
3. Cut protective roll pins for door hinges (Ø16 mm) – 8 items.
4. Insulation seals – 2 items.

Oversize	Possible
Number of hinges:	4, adjustable
Design & colour	Any design, finish, shape and colour
Architraves:	Included, 100 mm, x12 mm 45°, Glued (no holes)
Main Lock:	MOTTURA 8th series (with deadplate) security grade 7, in protective metal box MOTTURA CHAMPIONS PRO (3 keys)
Extra Lock:	Yes, DORMA (5 keys)
Hidden chain/night lock:	Included
Magnetic defender:	Included (2 keys)
Outside handle	Included
Inside handle	Included
Glass	Possible, security laminated, P6B, burglar proof
Fire resistance	Possible for 60 min
Threshold:	Stainless steel 15x20x115 mm
Metal construction:	For inside or outside conditions
Bullet resistance:	Possible up to FB6, BR6, standard steel or ballistic
Adjustable frame plate	Included
Additional upgrades:	All the same as RC3 and below: Bullet resistant glass up to BR6 Ballistic steel up to FB6 Manganese anti drill plate
MOTTURA bolts:	Yes @ the top and bottom of the door
Packing:	Wooden box

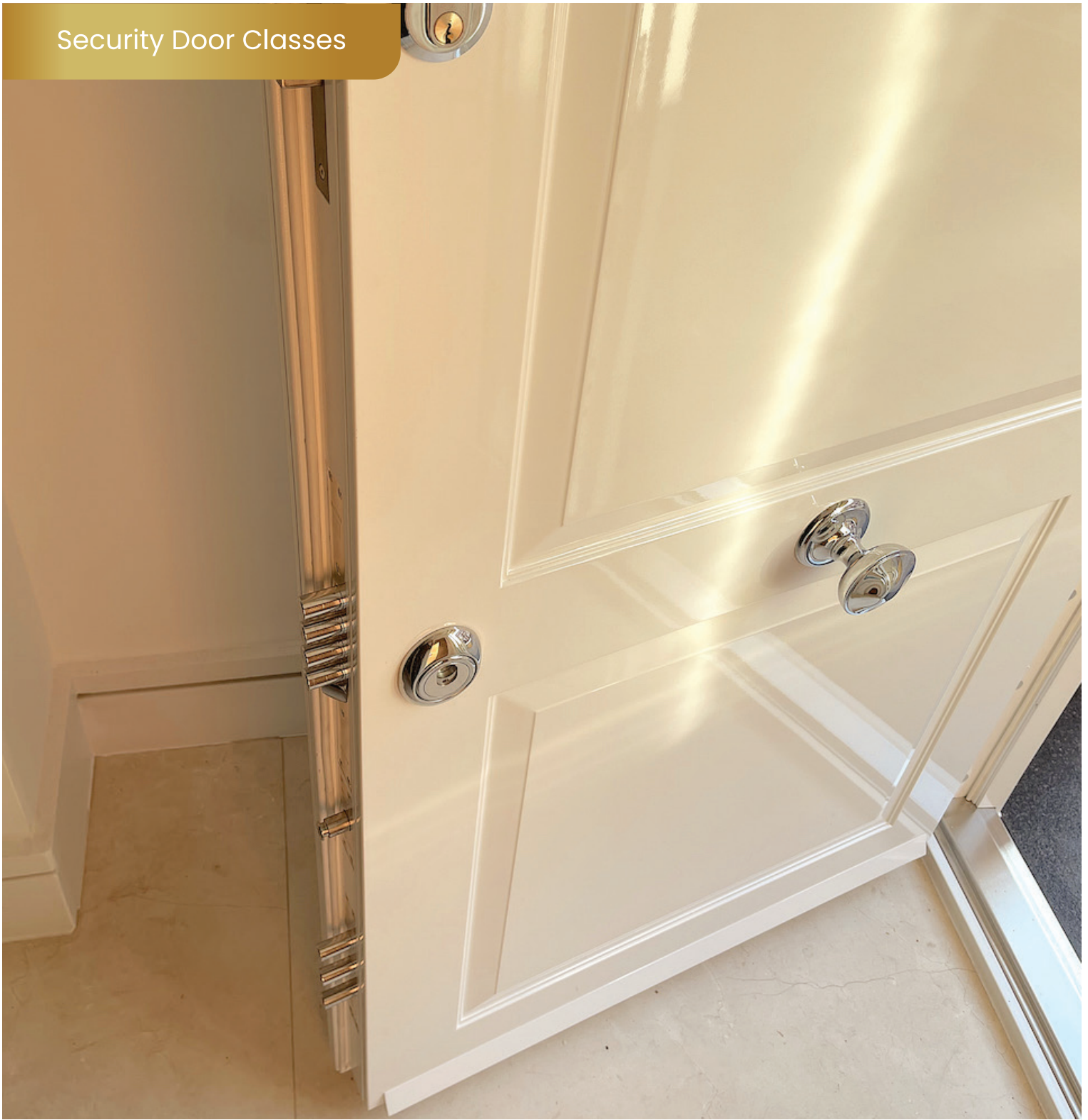

Cross section

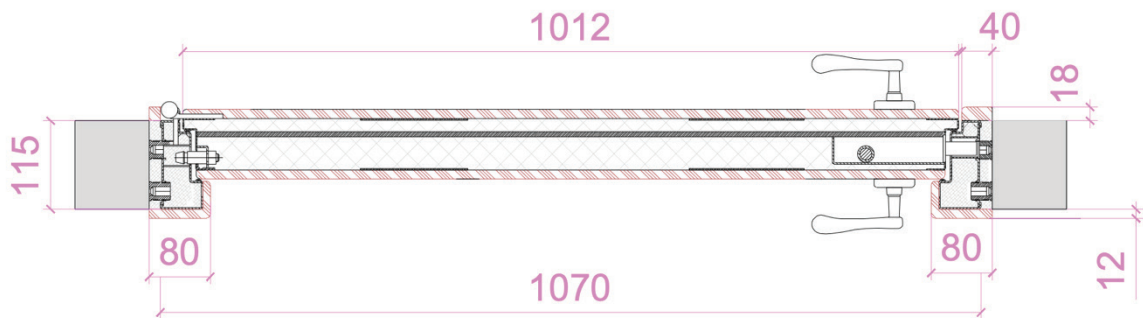

Locks & Cylinders

Mottura Class 7 by EN 12209 - Certification by EN 12209

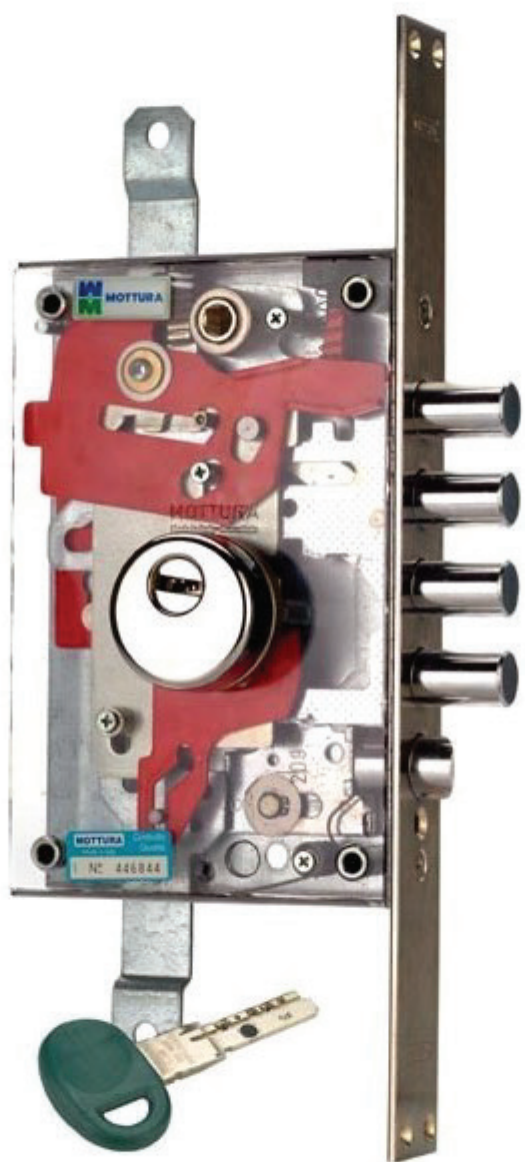

Mottura 85783

- Armoured cylinder lock. Locks in three directions. Original CHAMPIONS cylinder with the protection DEFENDER. Higher security lock. The lock has a unique patented MOTTURA security system against knocking or pulling out the cylinder. If the cylinder is broken and pulled out while the lock is locked, the lock blocks up and cannot be unlocked.
- 5 small patented keys
- 7 locking points
- 7 security class
- Made in Italy
- Warranty - 3 years



Champions C30/31

Double magnetic-mechanical coding system

- CHAMPIONS® 30 has five pins, of which one is positioned magnetically (patented)
- Shell and plug protected against drilling
- Widia pins
- Tempered steel anti-picklock shaped top and bottom pins
- Rest position of the cam off-centre with 30° respect to the cylinder profile to prevent it from exiting
- Possibility of master keying systems
- Frictioned cylinders available
- "Vario" option with 3 levels
- All thumb turn cylinders or provision for knob come frictioned standard
- A sealed packet includes the cylinder, owner's card, keys, installation instructions and fixing screw. For maximum security, keys and owner's card are sealed from the manufacturer
- The cylinders marked BKC are certified as bump-resistant



FIAM

- Main 3-point lock for security doors complete with a strike.
- Massive body, 4 bolts.
- Reversible latch.
- The silence of work and high burglary resistance of that lock is due to his patented gear mechanism.
- * Also available with anti-snap mechanical block system – if the protector and locking cylinder is broken the lock blocked automatically and cannot be opened without destruction.



R6 Plus

ISEO R6 Plus R6 Plus

- 6 billies, in a straight arrangement
- Safety shell with wills, inverted (double-sided)
- Delivered with 5 keys and 1 draft construction site
- Steel billies so that it can not be easily punctured (protection anti-drilling)
- Specially made billies against finding the key code (anti-picking protection)

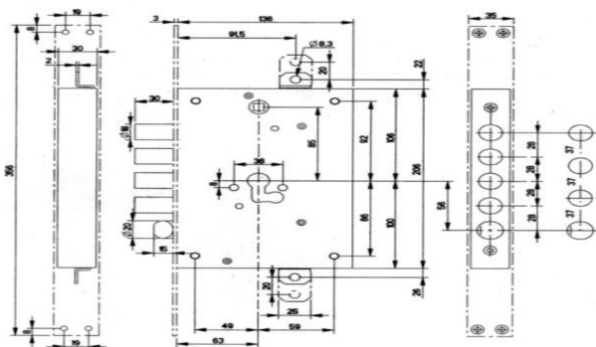

FIAM®

Millings

To enhance the beauty of our doors, we apply a high-quality exterior skin made from natural wood, veneer, plywood, or laminated materials. We also offer a wide selection of PVC films that mimic various wood finishes. Our exterior doors are wind-resistant, offer excellent thermal insulation, high soundproofing, and are waterproof. They are designed to stay attractive for many years. To ensure durability and top quality, we use specially selected, certified waterproof EDM for the finish of our entrance doors. Whether finished with paint or PVC laminate, our doors are easy to maintain and simple to clean.

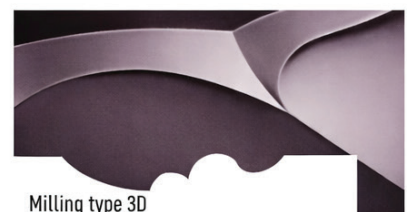
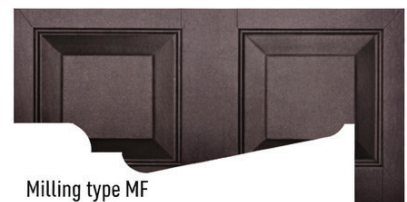
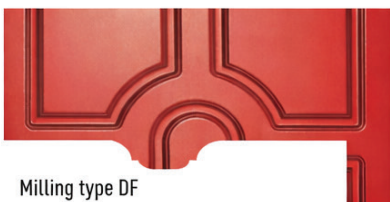
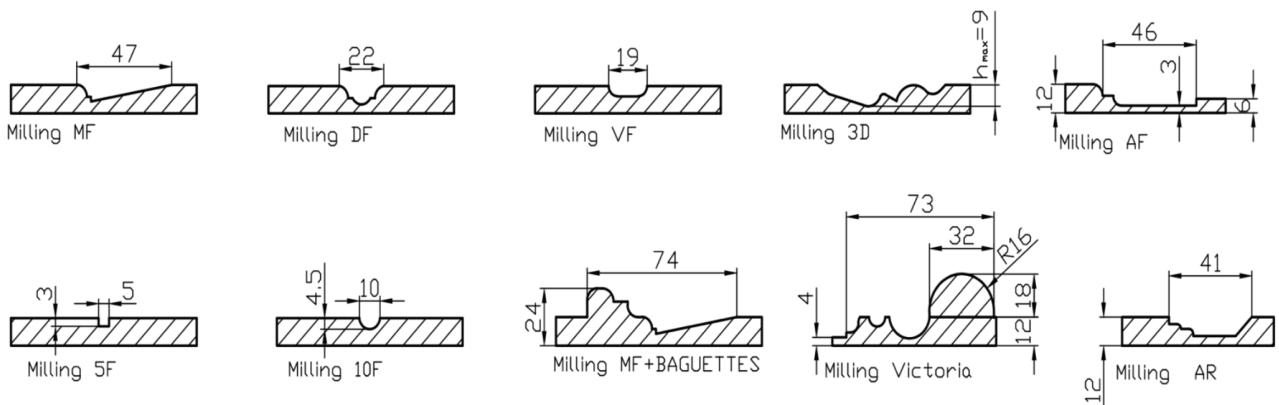



Standard Carvings

Choose a design from our range of nearly 200 carvings. Alternatively we will make your door from drawings prepared either by you, us or your architect.

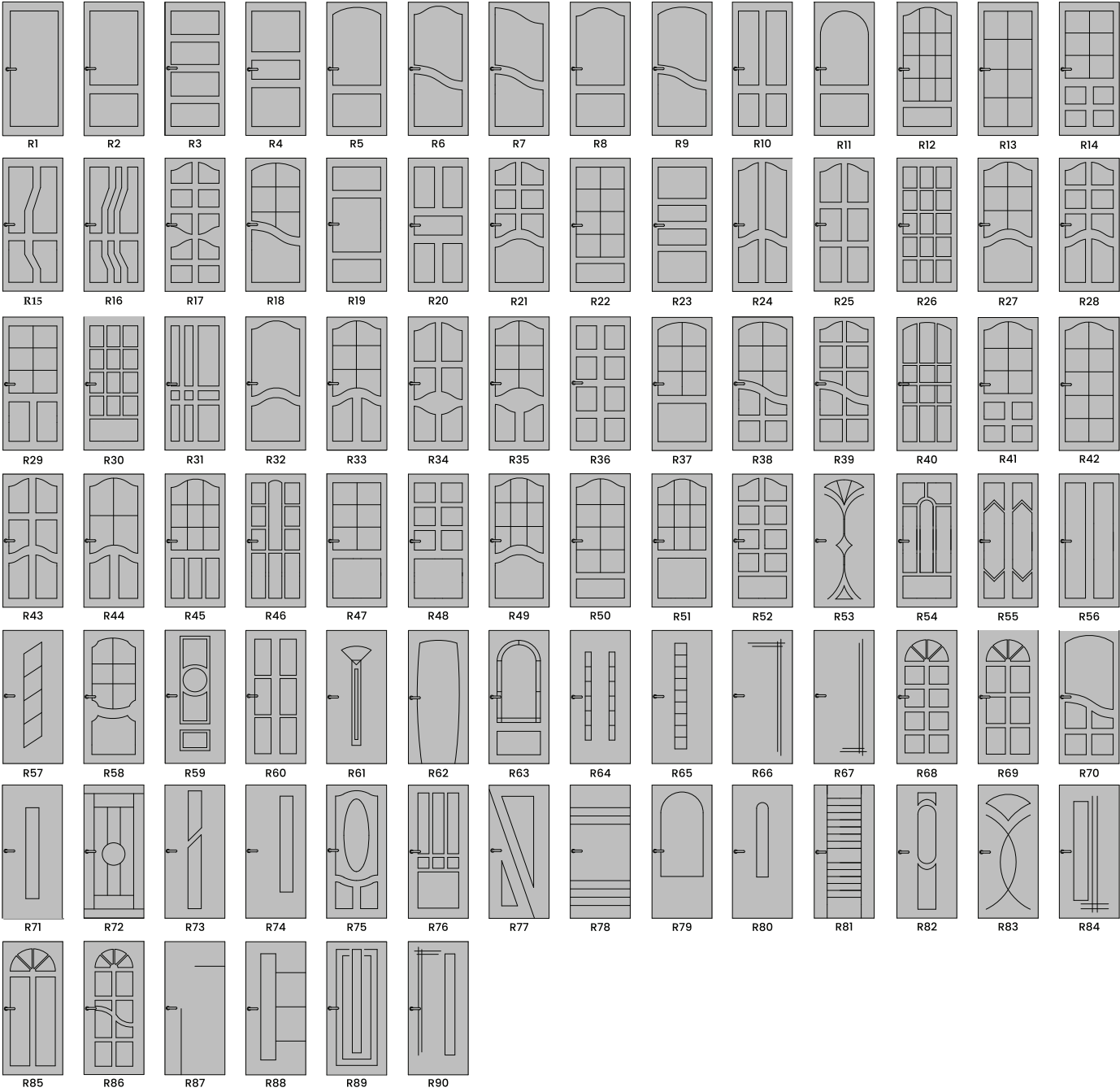

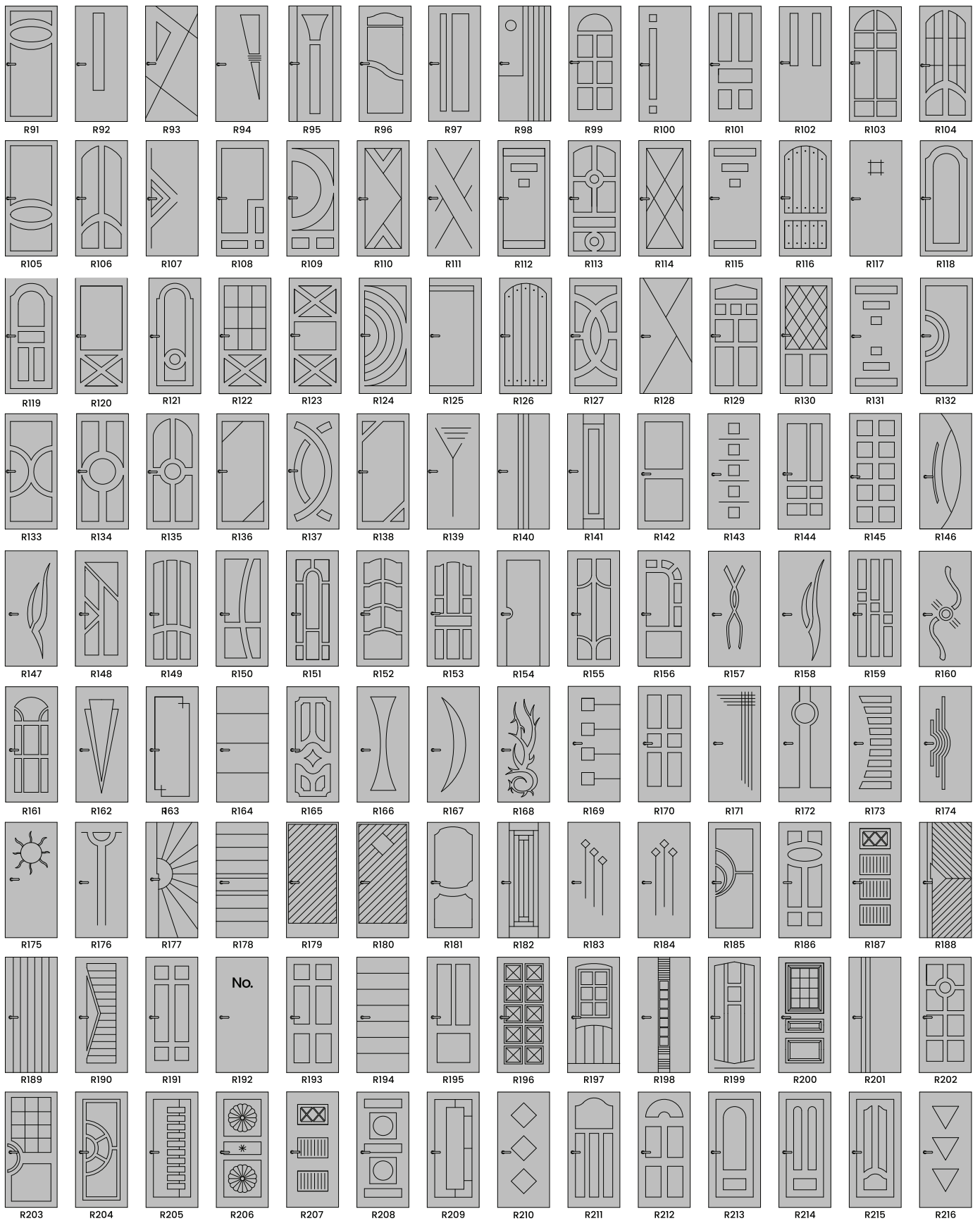



Door Finishes

Painting Colours

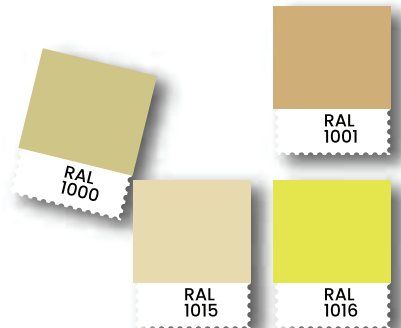

RAL 1033	RAL 1034	RAL 2000	RAL 2001	RAL 2002	RAL 2003	RAL 2004	RAL 2008	RAL 2009	RAL 2010
RAL 3013	RAL 3014	RAL 3015	RAL 3016	RAL 3017	RAL 3018	RAL 3020	RAL 3022	RAL 3027	RAL 3031
RAL 5000	RAL 5001	RAL 5002	RAL 5003	RAL 5004	RAL 5005	RAL 5007	RAL 5008	RAL 5009	RAL 5011
RAL 5023	RAL 5024	RAL 6000	RAL 6001	RAL 6002	RAL 6003	RAL 6004	RAL 6005	RAL 6006	RAL 6007
RAL 6018	RAL 6019	RAL 6020	RAL 6021	RAL 6022	RAL 6024	RAL 6025	RAL 6026	RAL 6027	RAL 6028
RAL 7006	RAL 7008	RAL 7009	RAL 7010	RAL 7011	RAL 7012	RAL 7013	RAL 7015	RAL 7016	RAL 7021
RAL 7036	RAL 7037	RAL 7038	RAL 7039	RAL 7040	RAL 7042	RAL 7043	RAL 7044	RAL 7045	RAL 7046
RAL 8014	RAL 8015	RAL 8016	RAL 8017	RAL 8019	RAL 8022	RAL 8023	RAL 8024	RAL 8025	RAL 8028

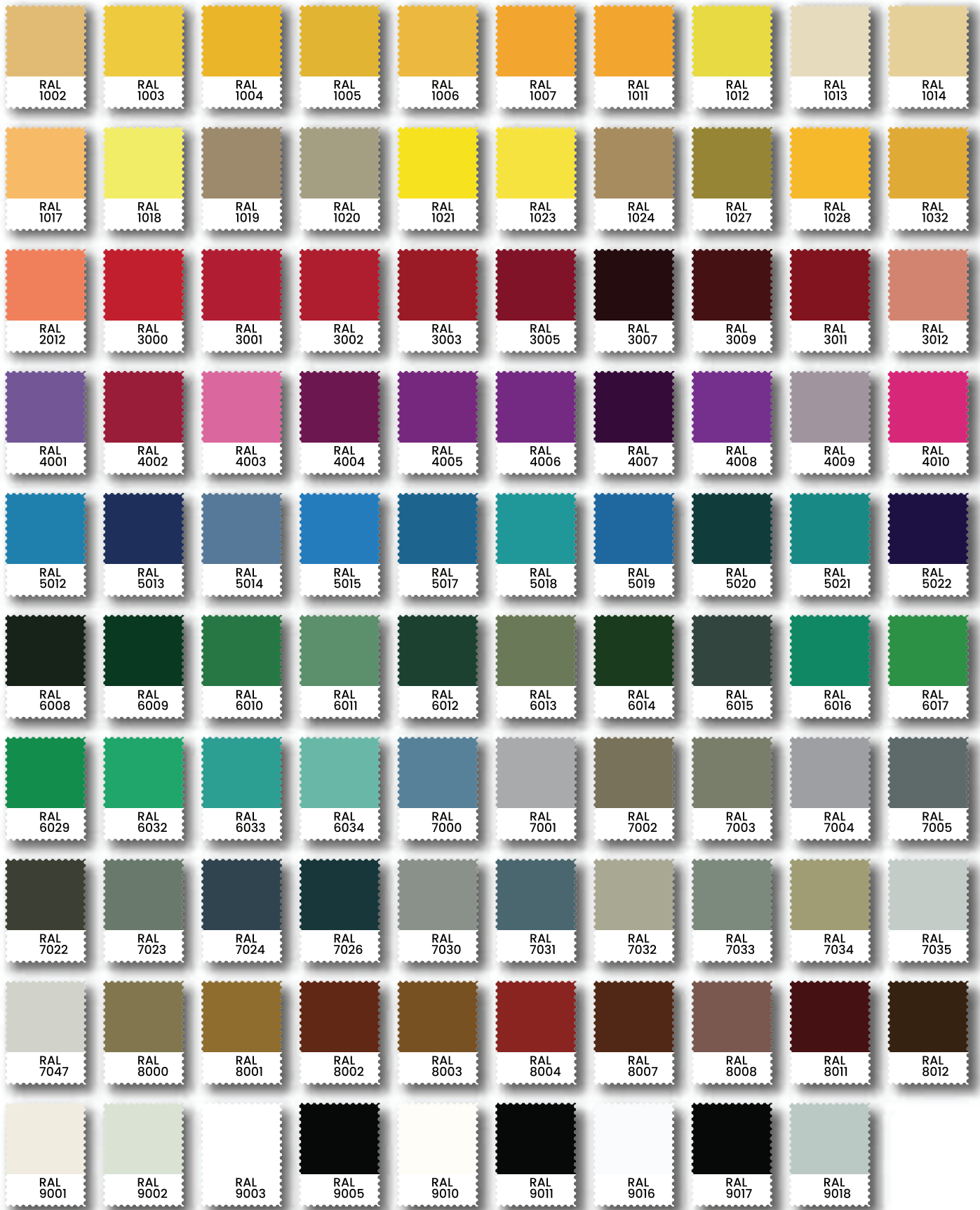

Metal Colours

The internal construction of the doors has no closed cavities, so the entire construction can be powder-coated in the following colours, providing long-term surface protection from corrosion.

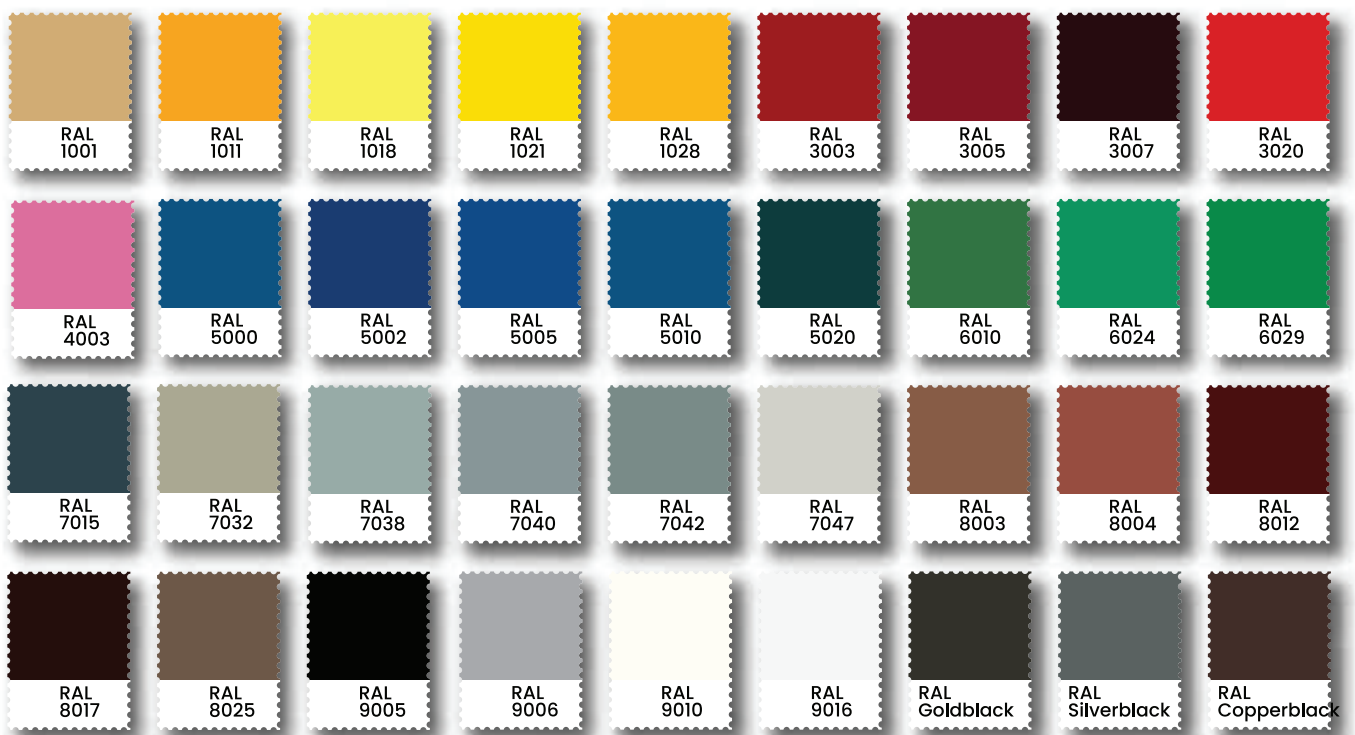

PVC film colours

PVC laminated MDF or Umidax-HLS board is especially resistant to scratching and chipping of corners.





Door Ironmongery

Just as you chose your door design and colours, you are free to select your ironmongery as well. We offer a wide variety of knobs, handles, and knockers, available in polished chrome, satin chrome and polished brass finishes. If you can't find exactly what you're looking for, we're here to help. Our goal is not only to secure your premises but also to bring your design vision to life.







Available Upgrades



Magnetic Defender



Drop Down Seal



Additional MOTTURA Bolts



Additional Locks



Concealed Door Closer



Night Chain



High Gloss



Gallery









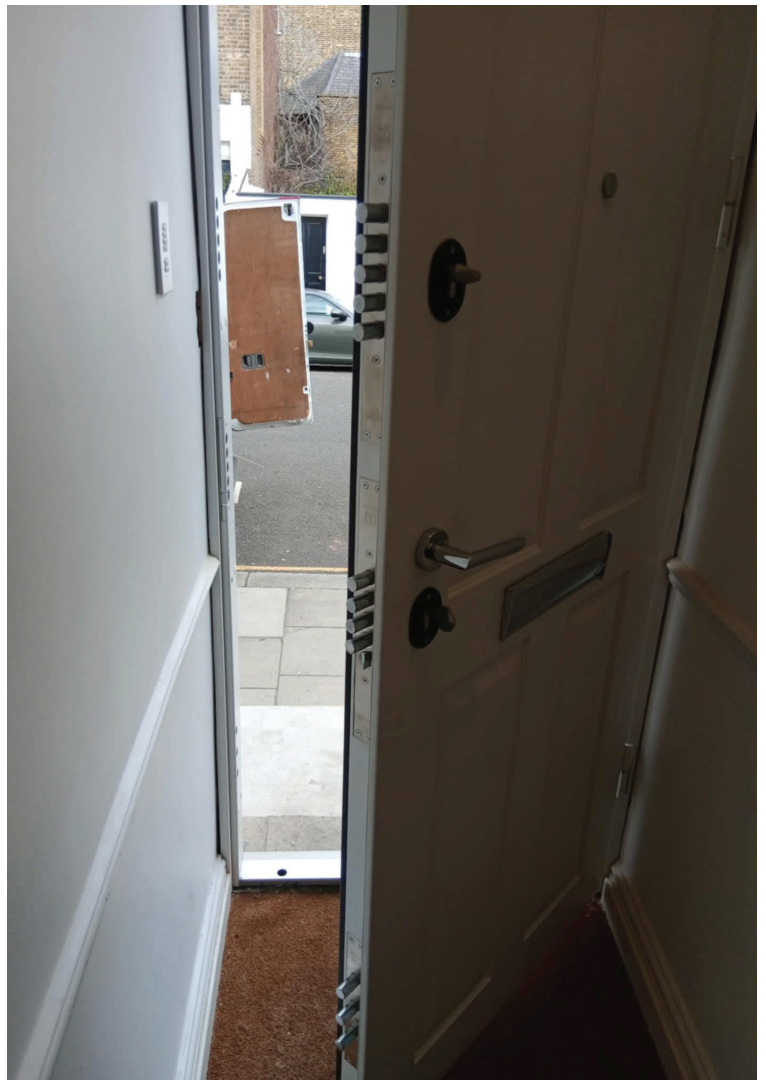





Top Security Doors

Top Security Doors LTD

Kemp House, 152 City Road,
London, EC1V 2NX

Company number: 10606919

Contact Us

+44 (0) 20 8099 9220

+44 (0) 77 7767 2020

info@topsecuritydoors.co.uk